

IVC-EH-4TC/8TC Thermocouple-type Temperature Input Module User Manual

Thanks for choosing the programmable logic controllers (PLCs) developed and produced by INVT Electric Co., Ltd. Before using the IVC-EH-4TC/8TC series PLC products, read this manual carefully to understand the product features, so that you can install and use the products properly and make full use of its abundant functions.

Note:

Before using the product, read the operation instructions and precautions carefully to prevent accidents. Only trained personnel can install and operate the product, and when installing and operating the product, the operators must strictly follow the related industrial safety specifications and the precautions and special safety guide provided in this manual to perform operations properly.

1 Interface description

1.1 Interface introduction

Cover plates are provided for the extension cable interfaces and user terminals of the IVC-EH-4TC/8TC module, as shown in Figure 1-1. You can see the extension cable interfaces and user terminals after opening the cover plates, as shown in Figure 1-2.

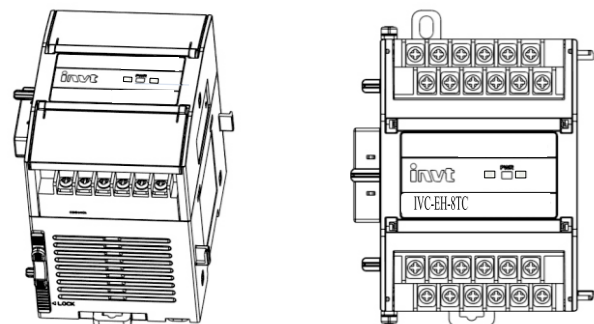

Figure 1-1 Module appearance diagram Figure 1-2 Module interface diagram

The IVC-EH-4TC/8TC module is connected to the main module through a patch board, and the extension modules are connected in cascade mode to implement hard connection. For the specific connection method, see the connection diagram in Figure 1-3.

Table 1-1 describes the definition of IVC-EH-4TC/8TC user terminals.

Table 1-1 Definition of IVC-EH-4TC/8TC user terminals

SN	Label	Description	SN	Label	Description
1	24V+	Positive pole of the 24 V analog power supply	11	L4+	Positive pole of the thermocouple of channel 4
2	24V-	Negative pole of the 24 V analog power supply	12	L4-	Negative pole of the thermocouple of channel 4
3	.	Empty pin	13	L5+	Positive pole of the thermocouple of channel 5
4	PG	Ground terminal	14	L5-	Negative pole of the thermocouple of channel 5
5	L1+	Positive pole of the thermocouple of channel 1	15	L6+	Positive pole of the thermocouple of channel 6
6	L1-	Negative pole of the thermocouple of channel 1	16	L6-	Negative pole of the thermocouple of channel 6
7	L2+	Positive pole of the thermocouple of channel 2	17	L7+	Positive pole of the thermocouple of channel 7
8	L2-	Negative pole of the thermocouple of channel 2	18	L7-	Negative pole of the thermocouple of channel 7
9	L3+	Positive pole of the thermocouple of channel 3	19	L8+	Positive pole of the thermocouple of channel 8
10	L3-	Negative pole of the thermocouple of channel 3	20	L8-	Negative pole of the thermocouple of channel 8

1.2 System connection

IVC-EH-4TC/8TC is applied to IVC3 series PLC systems. It can be connected to an IVC3 series system through hard connection, that is, inserting it into the extension interface of any extension module of the main module or system, as shown in Figure 1-3.

After the IVC-EH-4TC/8TC module is connected to the system, its extension interface can also be used to connect another extension module of the IVC3 series, such as the I/O extension module, VC-EH-4DA, IVC-EH-4TP, or another IVC-EH-4TC/8TC.

The main module of an IVC3 series PLC can be extended with multiple I/O extension modules and special function modules. The number of extension modules depends on the power that the module can supply. For details, see section 4.7 "Power supply specifications" in the IVC3 Series PLC User Manual.

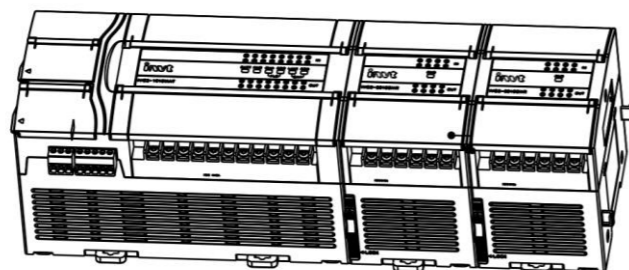

Figure 1-3 Diagram of the connection between IVC-EH-4TC/8TC analog input modules and the main module

1.3 Wiring description

Figure 1-4 shows the user terminal wiring requirements. Pay attention to the following seven aspects:

- The labels ① to ⑥ in Figure 1-4 indicate the connection that you need to pay special attention to.
- It is recommended that you connect the thermocouple signals by using a shielded twisted-pair cable, and keep the cable away from power cables or other cables that may cause electrical interference. Long compensation cables may be easily disrupted by noise. Therefore, it is recommended that you use compensation cables of shorter than 100 m. Measurement errors are caused by the impedance of compensation cables, and you can adjust the characteristic of each channel to eliminate the errors. For details, see section 3 "Characteristic setting".
- If too much electrical interference is caused, connect the shielding ground to the ground terminal PG of the module.
- Ground the ground terminal PG of the module properly.
- The auxiliary 24 V DC output power supply or any other power supply that meets requirements can be used as the analog power supply.
- Short-circuit the positive and negative terminals that do not use a channel to prevent the detection of error data on the channel.
- If multiple thermocouples need to be connected to the shielding ground, you can extend the module with external terminals.

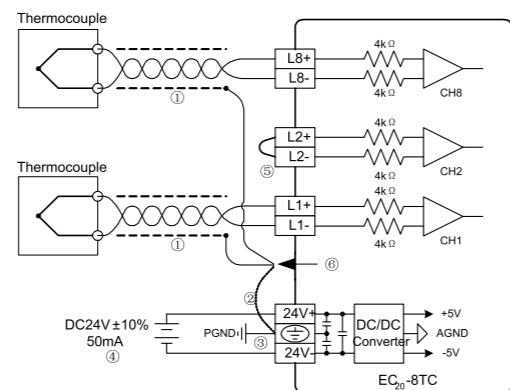

Figure 1-4 IVC-EH-4TC/8TC user terminal wiring diagram

2 Instructions

2.1 Power supply specifications

Table 2-1 Power supply specifications

Item	Specification
Analog circuit	24 V DC (-15%~+20%); Max. allowable ripple voltage: 5%; 55 mA (supplied by the main module or external power supply)
Digital circuit	5 V DC, 72 mA (supplied by the main module)

2.2 Performance specifications

Table 2-2 Performance specifications

Item	Specification				
	Degrees Celsius (°C)	Degrees Fahrenheit (°F)			
Number of I/O points	None				
Input signal	Thermocouple type: K, J, E, N, T, R, S (all applicable for cahnnels), 8 channels in total				
Converting speed	(240±2%) ms × 8 channels (The conversion is not performed for unused channels.)				
Rated temperature range	Type K	-100°C~1200°C	Type K	-148°F~2192°F	
	Type J	-100°C~1000°C	Type J	-148°F~1832°F	
	Type E	-100°C~1000°C	Type E	-148°F~1832°F	
	Type N	-100°C~1200°C	Type N	-148°F~2192°F	
	Type T	-200°C~400°C	Type T	-328°F~752°F	
	Type R	0°C~1600°C	Type R	32°F~2912°F	
	Type S	0°C~1600°C	Type S	32°F~2912°F	
Digital output	16-bit A/D conversion, stored in 16-bit binary complement code				
	Type K	-1000~12000	Type K	-1480~21920	
	Type J	-1000~10000	Type J	-1480~18320	
	Type E	-1000~10000	Type E	-1480~18320	
	Type N	-1000~12000	Type N	-1480~21920	
	Type T	-2000~4000	Type T	-3280~7520	
	Type R	0~16000	Type R	320~29120	
	Type S	0~16000	Type S	320~29120	
	Lowest resolution	Type K	0.8°C	Type K	1.44°F
		Type J	0.7°C	Type J	1.26°F
Type E		0.5°C	Type E	0.9°F	
Type N		1°C	Type N	1.8°F	
Lowest resolution	Type T	0.2°C	Type T	0.36°F	
	Type R	1°C	Type R	1.8°F	
	Type S	1°C	Type S	1.8°F	
Calibration point for the overall precision	±(0.5% of the full range + 1°C) Condensation point of pure water: 0°C/32°F				
	Analog circuits are isolated from digital circuits by using optocouplers. Analog circuits are isolated from the 24 V DC power supply through the DC/DC converter.				

Note: You can obtain data in the unit of °C or °F by setting the corresponding mode.

2.3 BFM

The IVC-EH-4TC/8TC module can exchange information with the main module through the buffer memory (BFM) in either of the following operation modes:

Mode 1

The channels and converting results are set quickly in the configuration interfaces. This is also a common mode in which special extension modules are set.

Mode 2

- The main module writes information to the BFM of IVC-EH-4TC/8TC through TO instructions to set IVC-EH-4TC/8TC.
- The main module reads the TC converting results of IVC-EH-4TC/8TC and other information in the BFM through FROM instructions.

Table 2-3 describes the information in the BFM of IVC-EH-4TC/8TC.

Table 2-3 Information in the BFM of IVC-EH-4TC/8TC

BFM	Information	Default value
#100	Average value of channel 1	0
#101	Average value of channel 2	0
#102	Average value of channel 3	0
#103	Average value of channel 4	0
#104	Average value of channel 5	0
#105	Average value of channel 6	0
#106	Average value of channel 7	0
#107	Average value of channel 8	0
#200	Current value of channel 1	0
#201	Current value of channel 2	0
#202	Current value of channel 3	0
#203	Current value of channel 4	0
#204	Current value of channel 5	0
#205	Current value of channel 6	0
#206	Current value of channel 7	0
#207	Current value of channel 8	0
#300	Module fault state word	0X0000
#400	Initialization instruction	Default value: 0
#500	Setting modification allowing instruction	Default value: 1 (modification allowed)
#700	Channel 1 mode word	0x0000
#701	Channel 2 mode word	0x0000
#702	Channel 3 mode word	0x0000
#703	Channel 4 mode word	0x0000
#704	Channel 5 mode word	0x0000
#705	Channel 6 mode word	0x0000
#706	Channel 7 mode word	0x0000
#707	Channel 8 mode word	0x0000
#800	Number of points of channel 1 average value	8(1-4096)
#801	Number of points of channel 2 average value	8(1-4096)
#802	Number of points of channel 3 average value	8(1-4096)
#803	Number of points of channel 4 average value	8(1-4096)
#804	Number of points of channel 5 average value	8(1-4096)
#805	Number of points of channel 6 average value	8(1-4096)
#806	Number of points of channel 7 average value	8(1-4096)
#807	Number of points of channel 8 average value	8(1-4096)
*#900	CH1-D0	Default value: 0
#901	CH1-A0	Default value: 0
*#902	CH1-D1	Default value: 12000
#903	CH1-A1	Default value: 12000
*#904	CH2-D0	Default value: 0
#905	CH2-A0	Default value: 0
*#906	CH2-D1	Default value: 12000
#907	CH2-A1	Default value: 12000
*#908	CH3-D0	Default value: 0
#909	CH3-A0	Default value: 0
*#910	CH3-D1	Default value: 12000
#911	CH3-A1	Default value: 12000
*#912	CH4-D0	Default value: 0
#913	CH4-A0	Default value: 0
*#914	CH4-D1	Default value: 12000
#915	CH4-A1	Default value: 12000
*#916	CH5-D0	Default value: 0
#917	CH5-A0	Default value: 0
*#918	CH5-D1	Default value: 12000
#919	CH5-A1	Default value: 12000
*#920	CH6-D0	Default value: 0
#921	CH6-A0	Default value: 0
*#922	CH6-D1	Default value: 12000
#923	CH6-A1	Default value: 12000
*#924	CH7-D0	Default value: 0
#925	CH7-A0	Default value: 0

BFM	Information	Default value
*#926	CH7-D1	Default value: 12000
#927	CH7-A1	Default value: 12000
*#928	CH8-D0	Default value: 0
#929	CH8-A0	Default value: 0
*#930	CH8-D1	Default value: 12000
#931	CH8-A1	Default value: 12000
#3000	Temperature at the cold end (for commissioning)	25°C
#4094	Module software version information	0X1000
#4095	Module identification code	0X4042

Description:

- Only for buffers with the asterisk (*), the main module can write information to the BFM of IVC-EH-4TC/8TC through TO instructions and read information of any unit in the BFM through FROM instructions. If the main module reads information from a reserved unit, the value 0 is obtained.
- The input mode depends on the value of BFM#700. #700 determines control channel 1, #701 determines control channel 2, #702 determines control channel 3, and #703 determines control channel 4. Table 2-4 describes the meaning of the values of the characters.

Table 2-4 BFM#700 information table

SN	BFM#700	Corresponding digital value
1	0	Channel disabled
2	1	K-type thermocouple, digital unit: 0.1°C (-100°C~+1200°C)
3	2	K-type thermocouple, digital unit: 0.1°F (-148°F~+2192°F)
4	3	J-type thermocouple, digital unit: 0.1°C (-100°C~+1000°C)
5	4	J-type thermocouple, digital unit: 0.1°F (-148°F~+1832°F)
6	5	E-type thermocouple, digital unit: 0.1°C (-100°C~+1000°C)
7	6	E-type thermocouple, digital unit: 0.1°F (-148°F~+1832°F)
	7	N-type thermocouple, digital unit: 0.1°C (-100°C~+1200°C)
	8	N-type thermocouple, digital unit: 0.1°F (-148°F~+2192°F)
	9	T-type thermocouple, digital unit: 0.1°C (-200°C~+400°C)
	A	T-type thermocouple, digital unit: 0.1°F (-328°F~+752°F)
	B	R-type thermocouple, digital unit: 0.1°C (0°C~1600°C)
	C	R-type thermocouple, digital unit: 0.1°F (32°F~2912°F)
	D	S-type thermocouple, digital unit: 0.1°C (0°C~1600°C)
	E	S-type thermocouple, digital unit: 0.1°F (32°F~2912°F)

For example, if "0x0001" is written into the #700 unit, the following information is set:

Channel mode of channel 1: K-type thermocouple, digital unit: 0.1°C (-100°C~+1200°C)

- The units BFM#800 to BFM#807 are the setting buffer memory for the average number of channel sampling times. The value ranges from 1 to 4096, and the default value 8 indicates that the average number of channel sampling times is 8.
- The units BFM#900 to BFM#931 are buffers for channel characteristic settings, and channel characteristics are set in two-point mode. D0 and D1 indicate the digital output (in the unit of 0.1°C) of the channel, A0 and A1 indicate the actual temperature value input (in the unit of 0.1°C) of the channel, and each channel uses 4 words. To simplify the setting of users without affecting the implementation of functions, the values of A0 and A1 are fixed to 0 and the maximum value in the applied mode. The values change with the modification of channel mode words (such as BFM#700). Users cannot modify these two items.

Note: The values of all the characteristic parameters are in the unit of 0.1°C. For values in the unit of °F, convert them into values in °C based on the following expression before writing them into the characteristic setting:

$$\text{Temperature value (°C)} = 5/9 \times [\text{Temperature value (°F)} - 32]$$

For how the channel characteristics change with the modification of D0, A0, D1, and A1, see chapter 3 "Characteristic setting".

- For state information of BFM#300, see Table 2-5.

Table 2-5 State information of BFM#300

Bit state of BFM#300	ON	OFF
b0: Error	If any of the bit states b1 to b2 is on, TC conversion of all channels is stopped.	No error

Bit state of BFM#300	ON	OFF
b1: Channel characteristic setting error	Exceptions occur in the channel characteristic data in the BFM or adjustment errors occur.	The channel characteristic data is normal.
b2: Power supply fault	24 V DC power supply fault	The power supply works properly.

Table 2-6 Channel state information of BFM#300

Channel	Bit	1	0
1	b4	Channel 1 decoupled	Channel 1 works properly
2	b5	Channel 1 decoupled	Channel 1 works properly
3	b6	Channel 1 decoupled	Channel 1 works properly
4	b7	Channel 1 decoupled	Channel 1 works properly
5	b8	Channel 1 decoupled	Channel 1 works properly
6	b9	Channel 1 decoupled	Channel 1 works properly
7	b10	Channel 1 decoupled	Channel 1 works properly
8	b11	Channel 1 decoupled	Channel 1 works properly
Reserved	b12–b15	/	/

- When BFM#400 is set to 1, that is, when it is activated, all the settings of the module are reset to the default values.
- BFM#500 is used to disable the modification of the I/O characteristic. After BFM#500 is set to 0, you cannot modify the I/O characteristic until BFM#500 is set to 1. The setting is saved at power outage.
- BFM#4094 contains the module software version information. You can use the FROM instruction to read the information.
- BFM#4095 contains the module identification code. The identification code of IVC-EH-4TC/8TC is 0X4042. User programs on the PLC can use this code to identify the special module IVC-EH-4TC/8TC before transmitting or receiving data.

3 Characteristic setting

The input channel characteristic of IVC-EH-4TC/8TC is the linear relationship between the analog input A and digital output D of the channel. You can set the characteristic. Each channel can be understood as the model shown in Figure 3-1. Since it is linear, the characteristic of a channel can be determined by identifying two points, P0 (A0, D0) and P1 (A1, D1). D0 indicates the channel digital output when the analog input is A0, and D1 indicates the channel digital output when the analog input is A1.

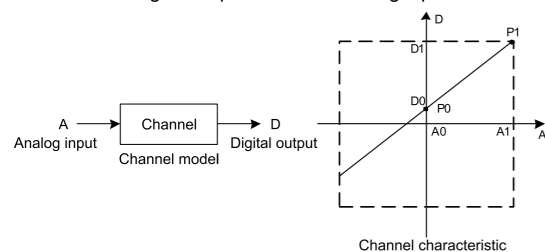

Figure 3-1 Channel characteristic of IVC-EH-4TC/8TC

Measurement errors are caused by the impedance of connection cables. Therefore, you can eliminate this type of errors by setting channel characteristics.

To simplify the setting of users without affecting the implementation of functions, the values of A0 and A1 are fixed to 0 and 12000 (in the unit of 0.1°C) in the applied mode, that is, in Figure 3-1, A0 is 0.0°C and A1 is 1200.0°C. Users cannot modify these two items.

If you do not modify D0 and D1 of each channel and only set the channel mode (BFM#700), the characteristic of each mode is the default one, as shown in Figure 3-2.

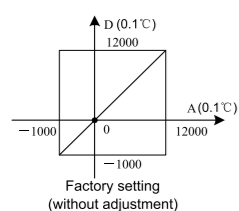

Figure 3-2 Default channel characteristic of each mode when D0 and D1 are not modified

Note: When the channel mode is set to 2, 4, ..., D, that is, the output is in the unit of 0.1°F, the temperature values read in the output area (BFM#100–#107 and BFM#200–#207) are in the unit of 0.1°F, but the data in the channel characteristic setting area (BFM#900–#931) is still in the unit of 0.1°C. Keep this in mind when modifying the values of D0 and D1.

If D0 and D1 of a channel are modified, the characteristic of the channel is changed. D0 and D1 can be increased or decreased by 1000 (in the unit of 0.1°C) based on the factory setting. D0 can be set to any value ranging from -1000 to +1000 (in the unit of 0.1°C), and D1 can be set to that ranging from 11000 to 13000 (in the unit of 0.1°C). If the setting exceeds the range, IVC-EH-4TC/8TC does not receive the setting and keep the original valid setting.

If the value measured by IVC-EH-4TC/8TC in practice is 5°C (41°F) higher, you can eliminate the error by setting the two adjustment points P0 (0, -50) and P1 (12000, 11950), as shown in Figure 3-3.

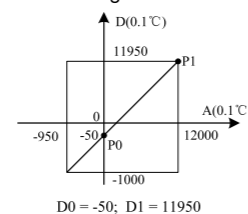

Figure 3-3 Characteristic modification instance

4 Application instance

4.1 Configuring the extension module through the configuration interface

In the following example, IVC-EH-4TC/8TC is connected to the No.0 position of the extension module. It is connected to a K-type thermocouple through channel 1 to output temperature values (°C), to a J-type thermocouple through channel 2 to output temperature values (°C), and to a K-type thermocouple through channel 3 to output temperature values (°F). Channel 4 is disabled, and the number of points of channel average value is set to 8. Data registers D1, D3, and D5 are used to receive the conversion results of the average values. Figure 4-1 to Figure 4-3 show the setting method. For more details, see the *IVC Series PLC Programming Reference Manual*.

You can configure registers directly in the provided extension module configuration interface instead of using FROM and TO instructions. The configuration steps are as follows:

- Double-click the extension module configuration tab in the **System block** category on **Project Manager**.
- Double-click the module to be configured on the right instruction tree to add it to the configuration.
- After configuring all the parameters, click **OK** to complete the configuration.

After the configuration is complete, the user program needs only to use the configured D element to communicate with the special function module instead of using FROM and TO instructions. After the compiling is verified, the system block is downloaded to the main module with the user program. Figure 4-1 shows the configuration interface.

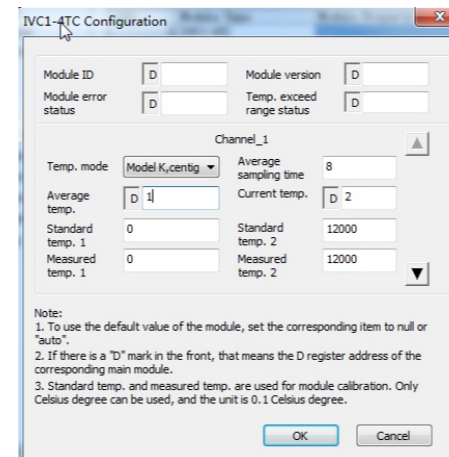

Figure 4-1 Setting of basic application channel 1

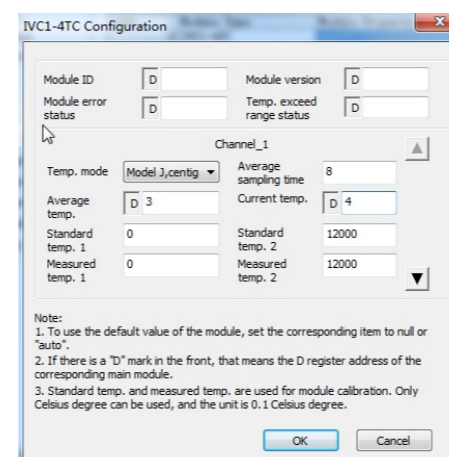

Figure 4-2 Setting of basic application channel 2

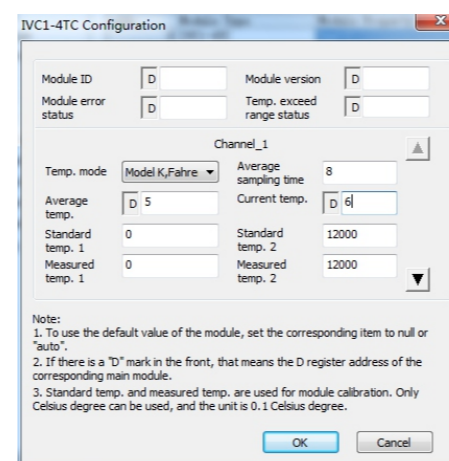
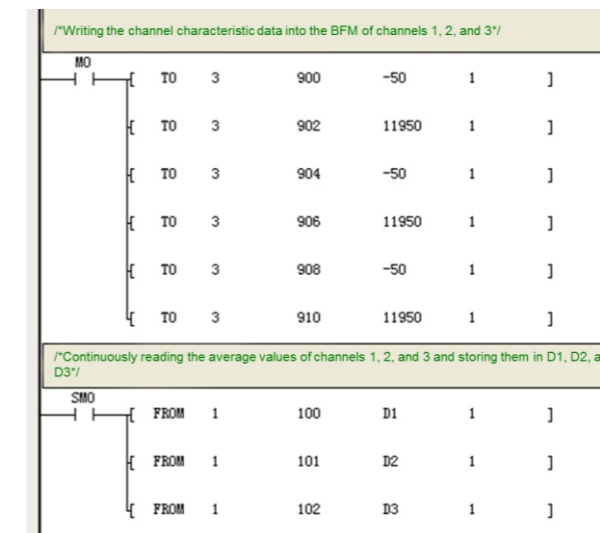
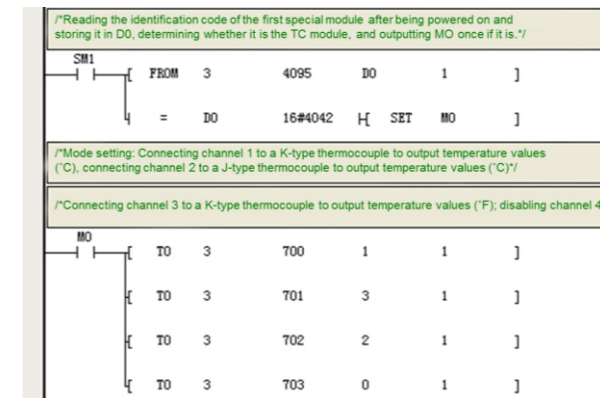

Figure 4-3 Setting of basic application channel 3

4.2 Configuring the extension module through instructions

Example: The address of the IVC-EH-4TC/8TC module is 3 (for the addressing method of special function modules, see the *IVC-EH-4TC/8TC Series PLC User Manual*), and the number of points of the average values is 8 by default. The following figure shows the modification of the characteristic shown in Figure 3-3. Channel 1 is used to connect to a K-type thermocouple to output temperature values (°C), channel 2 is used to connect to a J-type thermocouple to output temperature values (°C), channel 3 is used to connect to a K-type thermocouple to output temperature values (°F), and channel 4 is used to connect to a N-type thermocouple to output temperature values (°F). The channels 4, 5, 6, 7, and 8 are disabled, the number of points of channel average values is set to 8, and the data registers D2, D3, and D4 are used to receive the conversion results of the average values.



5 Running inspection

5.1 Routine inspection

- Check whether the wiring of the analog input meets the requirements. Refer to section 1.3 "Wiring description".
- Check whether IVC-EH-4TC/8TC is firmly inserted into the extension interface.
- Check whether the 5 V and 24 V power supplies are overloaded.
 - Note:** The power of the digital part of IVC-EH-4TC/8TC is supplied by the main module through the extension interface.
- Check the application program and ensure that the correct operation method and parameter range are selected in the application.
- Set the main module of IVC-EH-TC to the RUN state.

5.2 Fault checking

If IVC-EH-4TC/8TC does not run properly, check the following items:

- Check the state of the "POWER" indicator.
 - On: The extension interface is connected properly.
 - Off: Check the status of the extension connection and the main module.
- Check the analog wiring.
- Check the state of the "24V" indicator.
 - On: The 24 V DC power supply works properly.
 - Off: The 24 V DC power supply may be faulty. If the 24 V DC power supply works properly, IVC-EH-4TC/8TC is faulty.
- Check the state of the "RUN" indicator.
 - Blinking at a high frequency: IVC-EH-4TC/8TC runs properly.
 - Blinking at a low frequency or off: Check the information in BFM#300.

User notice

- The warranty covers only the PLC machine.
- The warranty period is 18 months.** We provide free-of-charge maintenance and repairs for the product if it is faulty or damaged during proper operation within the warranty period.
- The warranty period starts from the ex-factory date of the product.** The machine No. is the only basis for determining whether the machine is within the warranty period. A device without the machine No. is deemed out-of-warranty.
 - Faults are caused due to misoperations. Operations are not performed following the instructions provided in the manual.
 - The machine is damaged due to causes such as fire, flood, or voltage exceptions.
 - The machine is damaged due to improper use. You use the machine to perform some unsupported functions.
- Maintenance and repair fees are charged in the following scenarios even the product is within the warranty period:
 - The service fees are calculated based on the actual fees. If there is a contract, the provisions stated in the contract prevail.
- Keep this warranty card. Show it to the maintenance unit when you seek maintenance services.
- Contact the local dealer or directly contact our company if you have any questions.

Customer Service Center (China)

Shenzhen INVT Electric Co., Ltd.

Address: INVT Guangming Technology Building, Songbai Road, Matian, Guangming District, Shenzhen, China

Website: www.invt.com

All rights reserved. The contents in this document are subject to change without notice.



Customer service center

Shenzhen INVT Electric Co., Ltd.

Product quality feedback sheet

User name		Telephone	
User address		Postal code	
Product name and model		Installation date	
Machine No.			
Product appearance or structure			
Product performance			
Product material			
Quality in use			

Address: INVT Guangming Technology Building, Songbai Road, Matian, Guangming District, Shenzhen, China

Postal code: 518106